

Inductive sensor

Bi10-S30-AP6X

TURCK

Industrial
Automation

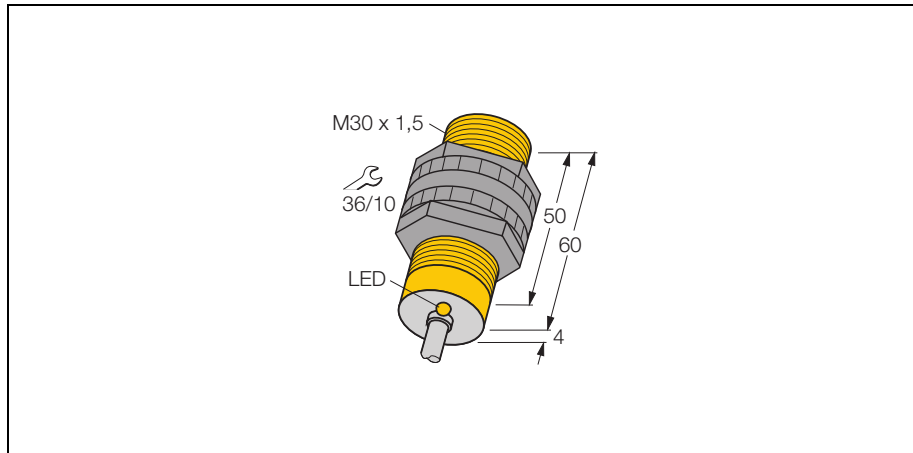

- threaded barrel, M30 x 1.5
- plastic, PA12-GF30
- 3-wire DC, 10...30 VDC
- normally open, pnp output
- cable connection

Wiring diagram

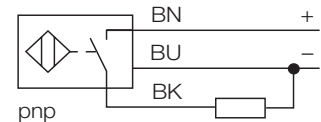

Functional principle

Inductive sensors are designed for wear-free and non-contact detection of metal objects. For this purpose they use a high-frequency electro-magnetic AC field that interacts with the target. Concerning inductive sensors, this field is generated by an LC resonant circuit with a ferrite core coil.

Type	Bi10-S30-AP6X
Ident-No.	46590
Rated operating distance Sn	10 mm
Mounting condition	flush
Assured sensing range	(0,81 x Sn) mm
Correction factors	St37 = 1, V2A ~ 0.7, Ms ~ 0.4, Al ~ 0.3
Repeatability	2 %
Temperature drift	± 10 %
Hysteresis	3... 15 %
Ambient temperature	-25...+ 70 °C
Operating voltage	10... 30VDC
Residual ripple	10 % U _{SS}
DC rated operational current	200 mA
No-load current I ₀	15 mA
Residual current	0.1 mA
Rated insulation voltage	0.5 kV
Short-circuit protection	yes / cyclic
Voltage drop at I _e	1.8V
Wire breakage / Reverse polarity protection	yes / complete
Output function	3-wire, normally open, pnp
Switching frequency	0.5 kHz
Housing	threaded barrel, M30 x 1.5
Dimensions	64 mm
Housing material	plastic, PA12-GF30
Material active face	plastic, PA12-GF30
End cap	plastic, EPTR
Tightening torque of housing nut	5 Nm
Connection	cable
Cable quality	Ø 5.2, LiYY, PVC, 2 m
Cable cross section:	3 x 0.34mm ²
Vibration resistance	55 Hz (1 mm)
Shock resistance	30g (11 ms)
Degree of protection	IP67
Display switch state	LED yellow

**Inductive sensor
Bi10-S30-AP6X**

Mounting instructions	minimum distances
Distance D	2 x B
Distance W	3 x Sn
Distance T	3 x B
Distance S	1,5 x B
Distance G	6 x Sn

Diameter of the active area B Ø 30 mm

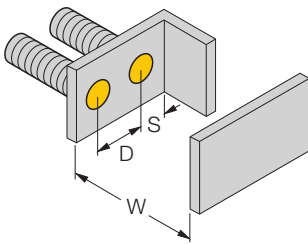
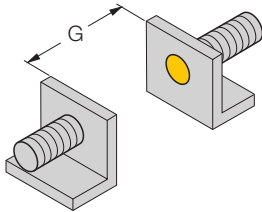
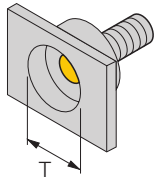

Inductive sensor Bi10-S30-AP6X

TURCK

Industrial
Automation

Accessories

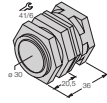
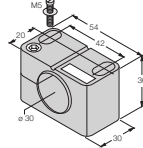
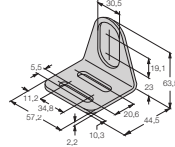
Type code	Ident-No.	Short text	Dimension drawing
QM-30	6945103	quick-mount fixing clamp with dead-stop; material: chrome-plated brass male thread M36 x 1.5. Note: The switching distance of proximity switches can be reduced by the use of quick mounting brackets.	
BST-30B	6947216	fixing clamp with dead-stop; material: PA6	
MW-30	6945005	mounting bracket; material: stainless steel A2 1.4301 (AISI 304)	
BSS-30	6901319	fixing clamp; material: polypropylene	