

Inductive Proximity Sensor in full metal housing

E2FM

- Full body stainless steel housing for highest mechanical protection
- Low frequency modulation for metal chip immunity
- Flame retardant cable for high protection against welding spatter damage



Application

Full body stainless steel housing with 0.8 mm thick sensing face protection

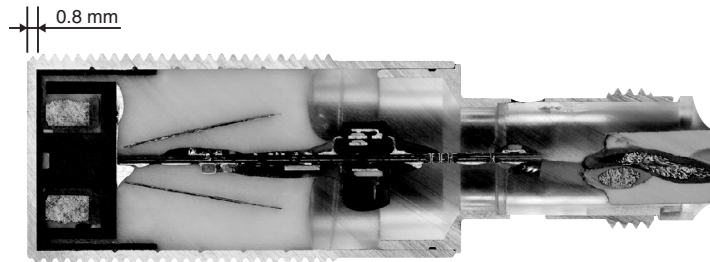

Brush Test

The stainless-steel head shows minimal wear when cleaned with a metal brush.

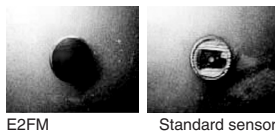

E2FM Standard sensor

Continuous Impact Test

More than 20 times the durability of standard sensors.



Standard sensor E2FM

The standard sensor with top wall thickness of 0.2 mm was penetrated after 10,000 impacts.

The E2FM was not penetrated after 250,000 impacts (depth: 0.26 mm).

Features

Chemical and Oil Resistance (examples)

Tested resistance against:

- Sodium chloride
- Gasoline
- Dilute sodium hydroxide
- Dilute hydrochloric acid
- Mineral oil
- Barium hydroxide

Low frequency modulation...

...for metal chip immunity reducing false signals caused by spatter accumulation and small metal objects.



Flush mounting installation possible

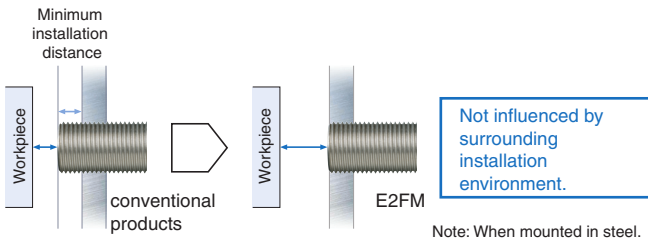

Ordering Information

Sensors

DC 2-Wire, Pre-wired Connector Models

Appearance	Sensing distance	Output configuration	Operation mode	Model	
Shielded 	M8	1.5 mm	NO	E2FM-X1R5D1-M1GJ	
	M12	2 mm		Polarity: Yes, Pin allocations: 1-4	E2FM-X2D1-M1GJ
				No polarity: No, Pin allocations: 3-4	E2FM-X2D1-M1GJ-T
	M18	5 mm		Polarity: Yes, Pin allocations: 1-4	E2FM-X5D1-M1GJ
				No polarity: No, Pin allocations: 3-4	E2FM-X5D1-M1GJ-T
	M30	10 mm		Polarity: Yes, Pin allocations: 1-4	E2FM-X10D1-M1GJ
				No polarity: No, Pin allocations: 3-4	E2FM-X10D1-M1GJ-T

DC 3-Wire, M12 Connector Models

Appearance	Sensing distance	Output configuration	Operation mode	Model
Shielded 	M8	DC 3-Wire, PNP	NO	E2FM-X1R5B1-M1
	M12			E2FM-X2B1-M1
	M18			E2FM-X5B1-M1
	M30			E2FM-X10B1-M1



Rating and Specifications

DC 2-Wire (E2FM-X□D□)

Size		M8	M12	M18	M30	M12	M18	M30	
Shielded		Shielded							
Item	Model	E2FM-X1R5D1 -M1GJ	E2FM-X2D1 -M1GJ	E2FM-X5D1 -M1GJ	E2FM-X10D1 -M1GJ	E2FM-X2D1 -M1GJ-T	E2FM-X5D1 -M1GJ-T	E2FM-X10D1 -M1GJ-T	
Sensing distance		1.5 mm±10%	2 mm±10%	5 mm±10%	10 mm±10%	2 mm±10%	5 mm±10%	10 mm±10%	
Set distance		0 to 1.05 mm	0 to 1.4 mm	0 to 3.5 mm	0 to 7 mm	0 to 1.4 mm	0 to 3.5 mm	0 to 7 mm	
Differential travel		15% max. of sensing distance							
Sensing object		Ferrous metal (The sensing distance decreases with non-ferrous metal. Refer to <i>Engineering Data</i> on page 5.)							
Standard sensing object		Iron, 8 × 8 × 1 mm	Iron, 12 × 12 × 1 mm	Iron, 30 × 30 × 1 mm	Iron, 54 × 54 × 1 mm	Iron, 12 × 12 × 1 mm	Iron, 30 × 30 × 1 mm	Iron, 54 × 54 × 1 mm	
Response frequency *		200 Hz	100 Hz	100 Hz	50 Hz	100 Hz	100 Hz	50 Hz	
Power supply voltage (operating voltage range)		12 to 24 VDC (10 to 30 VDC), ripple (p-p): 10% max.							
Leakage current		0.8 mA max.							
Output configuration		With polarity				Without polarity			
Control output	Switching capacity	3 to 100 mA							
	Residual voltage	3 V max. (Load current: 100 mA, Cable length: 2 m)				5 V max. (Load current: 100 mA, Cable length: 2 m)			
Indicators		Operation indicator (red LED), Setting/Operation indicator (green LED)							
Operation mode (with sensing object approaching)		NO							
Protection circuits		Surge suppressor, Load short-circuit protection							
Ambient temperature range		Operating/Storage: -25 to 70° C (with no icing or condensation)							
Ambient humidity range		Operating/Storage: 35% to 95% (with no condensation)							
Temperature influence		±20% max. of sensing distance at 23° C in the temperature range of -25 to 70° C.							
Voltage influence		±1% max. of sensing distance at rated voltage in the rated voltage ±15% range							
Insulation resistance		50 MΩ min. (at 500 VDC) between current-carrying parts and case							
Dielectric strength		1,000 VAC, 50/60 Hz for 1 minute between current carry parts and case							
Vibration resistance		Destruction: 10 to 55 Hz, 1.5 mm double amplitude for 2 hours each in X, Y, and Z directions							
Shock resistance		Destruction: 500 m/s ² 10 times each in X, Y, and Z directions		Destruction: 1,000 m/s ² 10 times each in X, Y, and Z directions					
Degree of protection		IEC 60529 IP67, DIN 40050 part 9: IP69k							
Connection method		Pig-tail Connector Models (Standard cable length: 0.3 m)							
Weight (packed state)		Approx. 65 g	Approx. 85 g	Approx. 110 g	Approx. 190 g	Approx. 85 g	Approx. 110 g	Approx. 190 g	
Materials	Case	Stainless steel (SUS303)							
	Sensing surface	Stainless steel (SUS303)							
	(thickness)	(0.4 mm)	(0.8 mm)				(0.8 mm)		
	Clamping nuts	Stainless steel (SUS303)							
	Cable	PVC (flame retardant)							
	Toothed washer	Zinc-plated iron							
Accessories		Instruction manual							

* The response frequency of the DC switching section is an average value. Measurement conditions are as follows: standard sensing object, a distance of twice the standard sensing object, and a set distance of half the sensing distance.

DC 3-Wire (E2FM-X□B□)

Size		M8	M12	M18	M30
Shielded		Shielded			
Item	Model	E2FM-X1R5B1-M1	E2FM-X2B1-M1	E2FM-X5B1-M1	E2FM-X10B1-M1
Sensing distance		1.5 mm±10%	2 mm±10%	5 mm±10%	10 mm±10%
Set distance		0 to 1.05 mm	0 to 1.4 mm	0 to 3.5 mm	0 to 7 mm
Differential travel		15% max. of sensing distance			
Sensing object		Ferrous metal (The sensing distance decreases with non-ferrous metal. Refer to <i>Engineering Data</i> on page 5.)			
Standard sensing object		Iron, 8 × 8 × 1 mm	Iron, 12 × 12 × 1 mm	Iron, 30 × 30 × 1 mm	Iron, 54 × 54 × 1 mm
Response frequency *		200 Hz	100 Hz	100 Hz	50 Hz
Power supply voltage (operating voltage range)		12 to 24 VDC (10 to 30 VDC), ripple (p-p): 10% max.			
Current consumption		10 mA max.			
Output configuration		PNP open collector output			
Control output	Switching capacity	200 mA max.			
	Residual voltage	2 V max. (Load current: 200 mA, Cable length: 2 m)			
Indicators		Operation indicator (yellow LED)			
Operation mode (with sensing object approaching)		NO			
Protection circuits		Reversed power supply polarity protection, Surge suppressor, Load short-circuit protection, and Reversed output polarity protection (except the E2FM-X1R5B1-M1)			
Ambient temperature range		Operating/Storage: -25 to 70°C (with no icing or condensation)			
Ambient humidity range		Operating/Storage: 35% to 95% (with no condensation)			
Temperature influence		±20% max. of sensing distance at 23°C in the temperature range of -25 to 70°C.			
Voltage influence		±1% max. of sensing distance in the rated voltage ±15% range (using the sensing distance at the rated voltage as standard)			
Insulation resistance		50 MΩ min. (at 500 VDC) between current-carrying parts and case			
Dielectric strength		1,000 VAC, 50/60 Hz for 1 minute between current carry parts and case			
Vibration resistance		Destruction: 10 to 55 Hz, 1.5-mm double amplitude for 2 hours each in X, Y, and Z directions			
Shock resistance		Destruction: 500 m/s ² 10 times each in X, Y, and Z directions		Destruction: 1,000 m/s ² 10 times each in X, Y, and Z directions	
Degree of protection		IEC 60529 IP67, DIN 40050 part 9: IP69k			
Connection method		Connector Models			
Weight (packed state)		Approx. 45 g	Approx. 55 g	Approx. 75 g	Approx. 160 g
Materials	Case	Stainless steel (SUS303)			
	Sensing surface	Stainless steel (SUS303)			
	(thickness)	(0.4mm)	(0.8mm)		
	Clamping nuts	Stainless steel (SUS303)			
	Toothed washer	Zinc-plated iron			
Accessories		Instruction manual			

* The response frequency of the DC switching section is an average value. Measurement conditions are as follows: standard sensing object, a distance of twice the standard sensing object, and a set distance of half the sensing distance.

Engineering Data (Typical)

Sensing Area

E2FM-X□

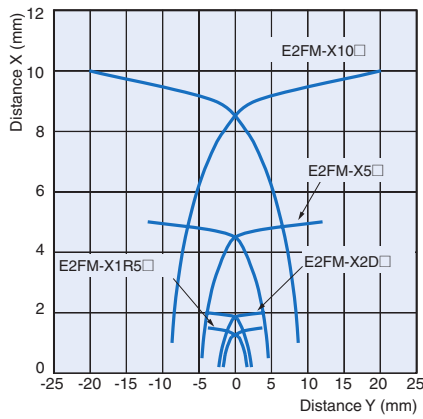

Influence of Sensing Object Size and Material

E2FM-X1R5□

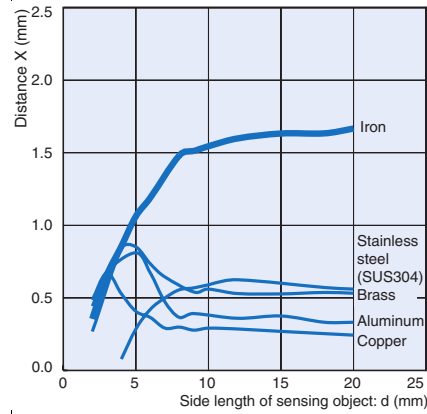

E2FM-X2□

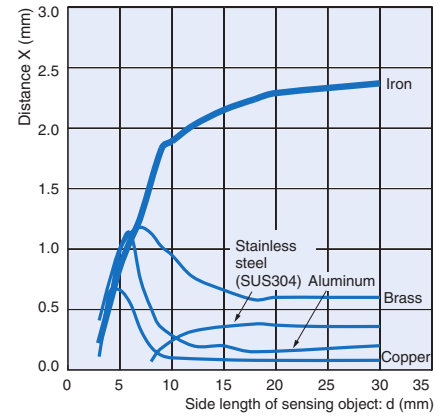

E2FM-X5□

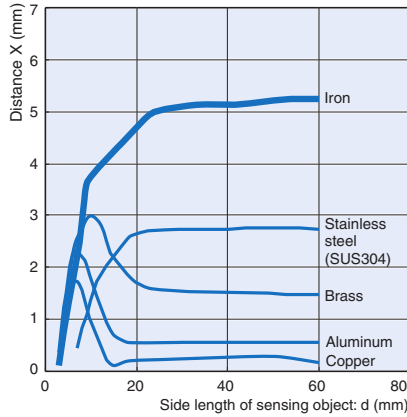

E2FM-X10□

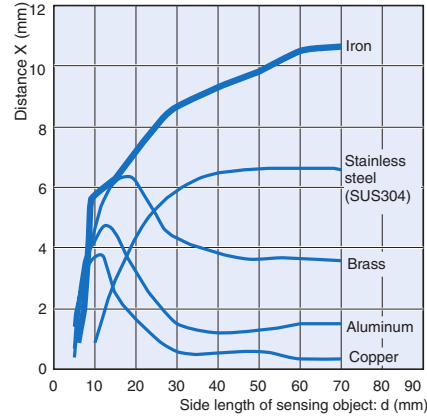

Leakage Current

E2FM-X□D1-M1GJ(-T)

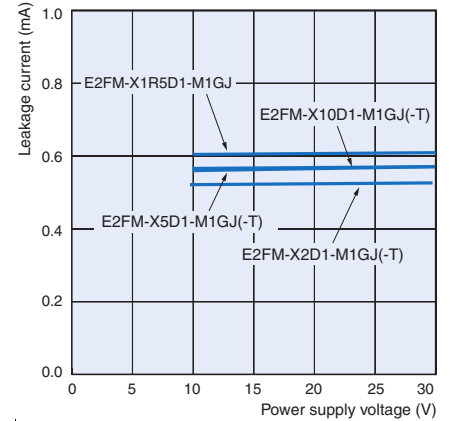

Residual Output Voltage

E2FM-X□B1-M1

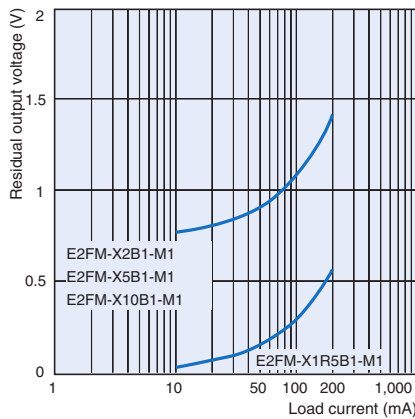

E2FM-X□D1-M1GJ(-T)

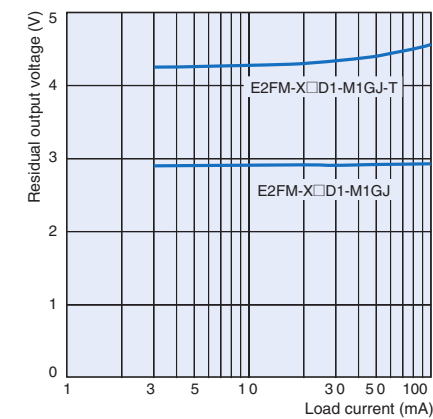

I/O Circuit Diagrams

DC 2-Wire Models

Operation mode	Model	Timing chart	Output circuit
NO	E2FM-X□D1-M1GJ	<p>Set position</p> <p>Non-sensing area Unstable sensing area Stable sensing area</p> <p>Sensing object</p> <p>(%) 100 70 (TYP) 0</p> <p>Rated sensing distance</p> <p>Proximity sensor</p>	<p>Connector Pin Arrangement</p> <p>Note: Pins 2 and 3 are not used.</p> <p>Note: The load can be connected to either the +V or 0 V side.</p>
	E2FM-X□D1-M1GJ-T	<p>ON Setting indicator (green)</p> <p>OFF</p> <p>ON Operation indicator (red)</p> <p>OFF</p> <p>ON Control output</p> <p>OFF</p>	<p>Connector Pin Arrangement</p> <p>Note: Pins 1 and 2 are not used.</p> <p>Note 1. The load can be connected to either the +V or 0 V side. Note 2. The E2FM-X□□1-M1GJ-T has no polarity. There is no need to be concerned about the polarity of pins 3 and 4.</p>

DC 3-Wire Models

Operation mode	Output configuration	Model	Timing chart	Output circuit
NO	PNP open-collector model	E2FM-X1R5B1-M1	<p>Non-sensing area Sensing area</p> <p>Sensing object</p> <p>(%) 100 0</p> <p>Rated sensing distance</p> <p>Proximity sensor</p>	<p>Connector Pin Arrangement</p> <p>Note: Pin 2 is not used.</p> <p>Note: There is no reversed output polarity protection diode.</p>
		E2FM-X2B1-M1 E2FM-X5B1-M1 E2FM-X10B1-M1	<p>ON Operation indicator (yellow)</p> <p>OFF</p> <p>ON Control output</p> <p>OFF</p>	<p>Connector Pin Arrangement</p> <p>Note: Pin 2 is not used.</p>

Safety Precautions

⚠ WARNING

This product is not designed or rated for ensuring safety of persons. Do not use it for such purposes.



Never use this product with an AC power supply. Otherwise, explosion may result.



Precautions for Safe Use

The following precautions must be observed to ensure safe operation.

1. Do not use the Sensor in an environment where inflammable or explosive gas is present.
2. Do not attempt to disassemble, repair, or modify any Sensors.
3. Power Supply Voltage
Do not use a voltage that exceeds the rated operating voltage range. Applying a voltage that is higher than the operating voltage range may result in explosion or fire.
4. Incorrect Wiring
Be sure that the power supply polarity and other wiring is correct. Incorrect wiring may cause explosion or fire.
5. Connection without a Load
If the power supply is connected directly without a load, the internal elements may explode or burn. Be sure to insert a load when connecting the power supply.

Precautions for Correct Use

Do not use the Sensor under ambient conditions that exceed the ratings to ensure maximum lifetime:

1. Please do not use the Sensor in the following locations.
 - (1) Outdoor locations directly subject to sunlight, rain, snow, or water droplets
 - (2) Locations subject to atmospheres with chemical vapors, in particular solvents and acids
 - (3) Locations subject to corrosive gas
2. The Sensor may malfunction if used near ultrasonic cleaning equipment, high-frequency equipment, transceivers, cellular phones, inverters, or other devices that generate a high-frequency electric field. Refer to the *Sensor General Catalog* for typical measures.
3. Laying the Sensor wiring in the same conduit or duct as high-voltage wires or power lines may result in incorrect operation and damage due to induction. Wire the Sensor using a separate conduit or independent conduit.
4. Cleaning
Never use thinner or other solvents. Otherwise, the Sensor surface may be dissolved.

Design

Influence of Surrounding Metal

When the Proximity Sensor is embedded in metal, make sure that the clearances given in the following table are maintained. The values depend on the type of nuts used for mounting. Be sure to use the supplied nuts (SUS303).

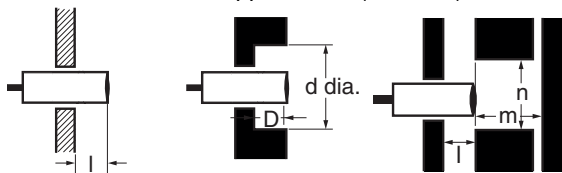

(Unit: mm)

Model	Item	Embedding material	l	d	D	m	n
E2FM-X1R5□	Item	Iron	0	8	0	4.5	30
		Aluminum	10	50	10	4.5	50
E2FM-X2□	Item	Iron	0	12	0	8	40
		Aluminum	16	70	16	8	70
E2FM-X5□	Item	Iron	0	18	0	20	60
		Aluminum	16	80	16	20	80
E2FM-X10□	Item	Iron	0	30	0	40	100
		Aluminum	24	120	24	40	120

Note: The influence from other non-magnetic surrounding metals is nearly the same as that from aluminum.

Mutual Interference

When installing two or more Sensors face-to-face or side-by-side, ensure that the minimum distances given in the following table are maintained.

(Unit: mm)

Model	Item	A	B
E2FM-X1R5□	Item	35	30
E2FM-X2□	Item	40	35
E2FM-X5□	Item	65	60
E2FM-X10□	Item	110	100

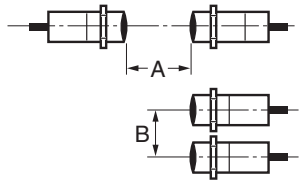

Chips from Cutting Aluminum or Cast Iron

Normally, chips from cutting aluminum or cast iron will not cause a detection signal to be output even if it adheres to or accumulates on the detection surface. In the following cases, however, a detection signal may be output. Remove the cutting chips in these cases.

1. If $d \geq \frac{2}{3} D$ at the center of the detection surface where d is the cutting chip size and D is the detection surface size

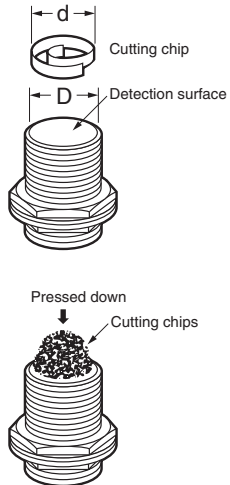

Model	Dimension (mm)	D
E2FM-X1R5□	Dimension (mm)	6
E2FM-X2□	Dimension (mm)	10
E2FM-X5□	Dimension (mm)	16
E2FM-X10□	Dimension (mm)	28

Mounting

Do not tighten the nut with excessive force. A washer must be used with the nut. Do not use tightening force that exceeds the values in the following table.

Model	Torque
E2FM-X1R5□	9 N·m
E2FM-X2□	30 N·m
E2FM-X5□	70 N·m
E2FM-X10□	180 N·m



Dimensions

(Unit: mm)

Sensors

Pig-tail Connector Models

E2FM-X1R5D1-M1GJ

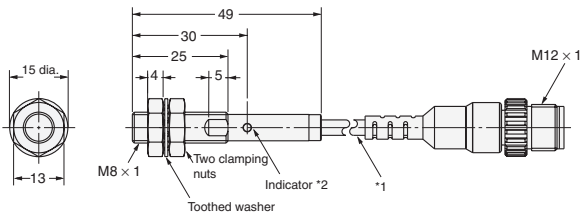

*1. 4-dia. vinyl-insulated round cable (flame retardant), Standard length; 300 mm
 *2. Operation indicator (red/green)
 Setting indicator (green)

E2FM-X2D1-M1GJ
 E2FM-X2D1-M1GJ-T

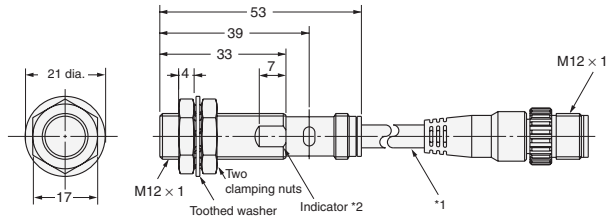

*1. 6-dia. vinyl-insulated round cable (flame retardant), Standard length; 300 mm
 *2. Operation indicator (red/green)
 Setting indicator (green)

E2FM-X5D1-M1GJ
 E2FM-X5D1-M1GJ-T

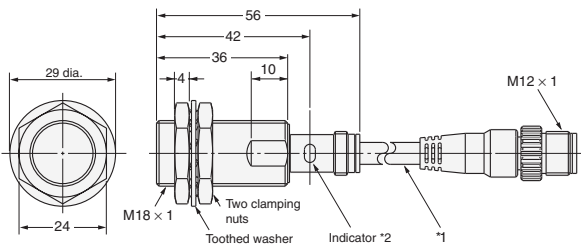

*1. 6-dia. vinyl-insulated round cable (flame retardant), Standard length; 300 mm
 *2. Operation indicator (red/green)
 Setting indicator (green)

E2FM-X10D1-M1GJ
 E2FM-X10D1-M1GJ-T

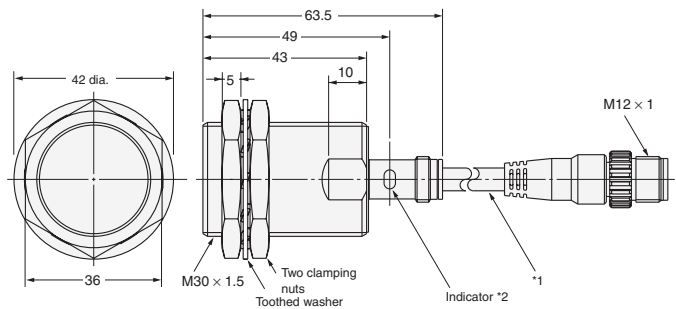

*1. 6-dia. vinyl-insulated round cable (flame retardant), Standard length; 300 mm
 *2. Operation indicator (red/green)
 Setting indicator (green)

M12 Connector Models

E2FM-X1R5B1-M1

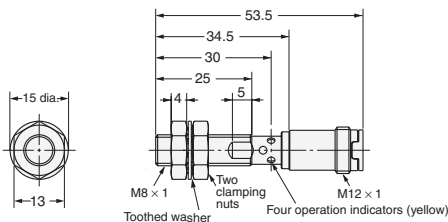

E2FM-X2B1-M1

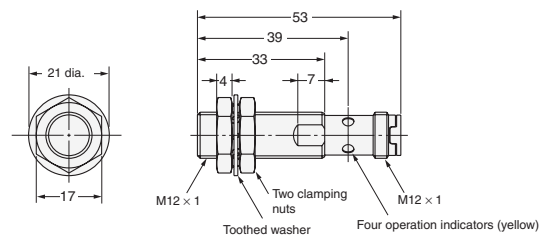

E2FM-X5B1-M1

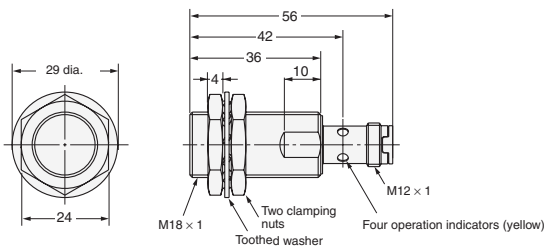

E2FM-X10B1-M1

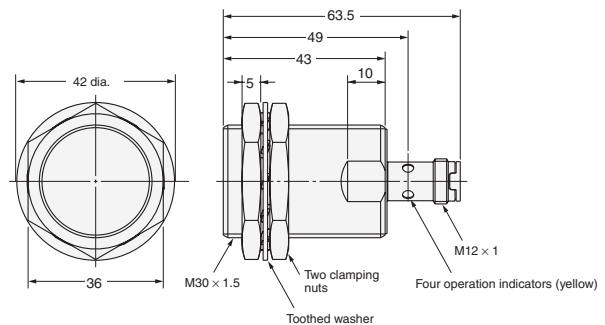

Mounting Hole Dimensions

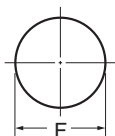

Dimension	M8	M12	M18	M30
F (mm)	8.5 ^{+0.5} ₀ dia.	12.5 ^{+0.5} ₀ dia.	18.5 ^{+0.5} ₀ dia.	30.5 ^{+0.5} ₀ dia.

READ AND UNDERSTAND THIS DOCUMENT

Please read and understand this document before using the products. Please consult your OMRON representative if you have any questions or comments.

WARRANTY

OMRON's exclusive warranty is that the products are free from defects in materials and workmanship for a period of one year (or other period if specified) from date of sale by OMRON.

OMRON MAKES NO WARRANTY OR REPRESENTATION, EXPRESS OR IMPLIED, REGARDING NON-INFRINGEMENT, MERCHANTABILITY, OR FITNESS FOR PARTICULAR PURPOSE OF THE PRODUCTS. ANY BUYER OR USER ACKNOWLEDGES THAT THE BUYER OR USER ALONE HAS DETERMINED THAT THE PRODUCTS WILL SUITABLY MEET THE REQUIREMENTS OF THEIR INTENDED USE. OMRON DISCLAIMS ALL OTHER WARRANTIES, EXPRESS OR IMPLIED.

LIMITATIONS OF LIABILITY

OMRON SHALL NOT BE RESPONSIBLE FOR SPECIAL, INDIRECT, OR CONSEQUENTIAL DAMAGES, LOSS OF PROFITS OR COMMERCIAL LOSS IN ANY WAY CONNECTED WITH THE PRODUCTS, WHETHER SUCH CLAIM IS BASED ON CONTRACT, WARRANTY, NEGLIGENCE, OR STRICT LIABILITY.

In no event shall responsibility of OMRON for any act exceed the individual price of the product on which liability is asserted.

IN NO EVENT SHALL OMRON BE RESPONSIBLE FOR WARRANTY, REPAIR, OR OTHER CLAIMS REGARDING THE PRODUCTS UNLESS OMRON'S ANALYSIS CONFIRMS THAT THE PRODUCTS WERE PROPERLY HANDLED, STORED, INSTALLED, AND MAINTAINED AND NOT SUBJECT TO CONTAMINATION, ABUSE, MISUSE, OR INAPPROPRIATE MODIFICATION OR REPAIR.

SUITABILITY FOR USE

THE PRODUCTS CONTAINED IN THIS DOCUMENT ARE NOT SAFETY RATED. THEY ARE NOT DESIGNED OR RATED FOR ENSURING SAFETY OF PERSONS, AND SHOULD NOT BE RELIED UPON AS A SAFETY COMPONENT OR PROTECTIVE DEVICE FOR SUCH PURPOSES. Please refer to separate catalogs for OMRON's safety rated products.

OMRON shall not be responsible for conformity with any standards, codes, or regulations that apply to the combination of products in the customer's application or use of the product.

At the customer's request, OMRON will provide applicable third party certification documents identifying ratings and limitations of use that apply to the products. This information by itself is not sufficient for a complete determination of the suitability of the products in combination with the end product, machine, system, or other application or use.

The following are some examples of applications for which particular attention must be given. This is not intended to be an exhaustive list of all possible uses of the products, nor is it intended to imply that the uses listed may be suitable for the products:

- Outdoor use, uses involving potential chemical contamination or electrical interference, or conditions or uses not described in this document.
- Nuclear energy control systems, combustion systems, railroad systems, aviation systems, medical equipment, amusement machines, vehicles, safety equipment, and installations subject to separate industry or government regulations.
- Systems, machines, and equipment that could present a risk to life or property.

Please know and observe all prohibitions of use applicable to the products.

NEVER USE THE PRODUCTS FOR AN APPLICATION INVOLVING SERIOUS RISK TO LIFE OR PROPERTY WITHOUT ENSURING THAT THE SYSTEM AS A WHOLE HAS BEEN DESIGNED TO ADDRESS THE RISKS, AND THAT THE OMRON PRODUCT IS PROPERLY RATED AND INSTALLED FOR THE INTENDED USE WITHIN THE OVERALL EQUIPMENT OR SYSTEM.

PERFORMANCE DATA

Performance data given in this document is provided as a guide for the user in determining suitability and does not constitute a warranty. It may represent the result of OMRON's test conditions, and the users must correlate it to actual application requirements. Actual performance is subject to the OMRON Warranty and Limitations of Liability.

CHANGE IN SPECIFICATIONS

Product specifications and accessories may be changed at any time based on improvements and other reasons.

It is our practice to change model numbers when published ratings or features are changed, or when significant construction changes are made. However, some specifications of the product may be changed without any notice. When in doubt, special model numbers may be assigned to fix or establish key specifications for your application on your request. Please consult with your OMRON representative at any time to confirm actual specifications of purchased products.

DIMENSIONS AND WEIGHTS

Dimensions and weights are nominal and are not to be used for manufacturing purposes, even when tolerances are shown.

ERRORS AND OMISSIONS

The information in this document has been carefully checked and is believed to be accurate; however, no responsibility is assumed for clerical, typographical, or proofreading errors, or omissions.

PROGRAMMABLE PRODUCTS

OMRON shall not be responsible for the user's programming of a programmable product, or any consequence thereof.

COPYRIGHT AND COPY PERMISSION

This document shall not be copied for sales or promotions without permission.

This document is protected by copyright and is intended solely for use in conjunction with the product. Please notify us before copying or reproducing this document in any manner, for any other purpose. If copying or transmitting this document to another, please copy or transmit it in its entirety.

Cat. No. D104-E2-01-X

In the interest of product improvement, specifications are subject to change without notice.

OMRON EUROPE B.V.

Wegalaan 67-69,
NL-2132 JD, Hoofddorp,
The Netherlands
Phone: +31 23 568 13 00
Fax: +31 23 568 13 88
www.eu.omron.com



Casp System Sp. Z o.o., Puzzkina 2, 43-603 Jaworzno, Polska, www.casp.pl, e-mail: biuro@casp.pl, tel/fax: +48 32 614 09 17